

## Description

IRE is a range of insulated in-line centrifugal duct fans. They provide high pressure with low sound level. The IRE fans have good sound and fire insulation qualities provided by a 50mm pad of mineral wool. The high quality ball bearing mounted external rotor motors are maintenance free. They can be speed controlled from 0-100% by voltage variation. All motors are protected by approved thermo contacts. All 3-phase motors have ready fitted thermo contact leads for alarm functions etc. The fans have a strong galvanized steel housing incorporating a swing out design of the fan motor and impeller for easy cleaning and inspection.



## Technical data

Parameter	Value	Unit
Voltage	400	V
Phase	3	~
Frequency	50	Hz
Power	4	kW
Current	7	A
R.p.m.	870	r/m
Max. temperature of transported air	60	°C
Max. temperature of transported air when speed-controlled	50	°C
Sound pressure level at 3 m	51	dB(A)
Length	990	mm
Width	952	mm
Height	705	mm
Weight	105	kg
Enclosure class, motor	44	IP
Insulation class, motor	F	
Duct connection	ø630 mm	

Diagrams

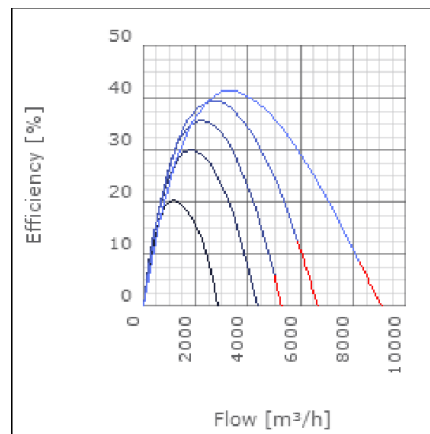
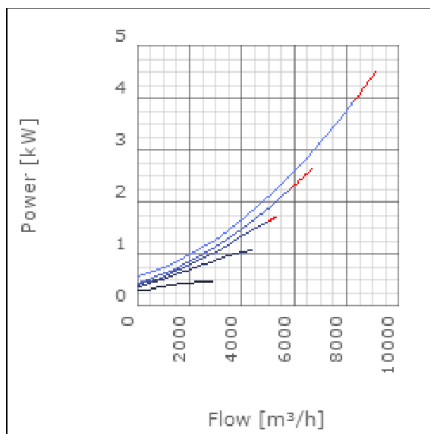
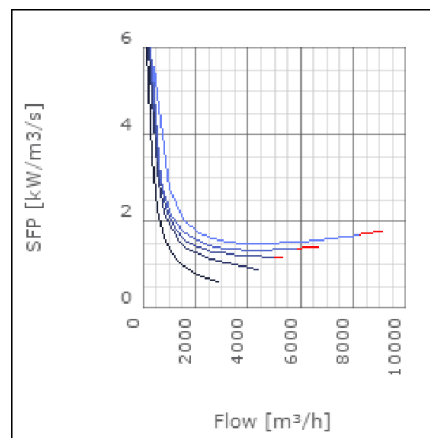
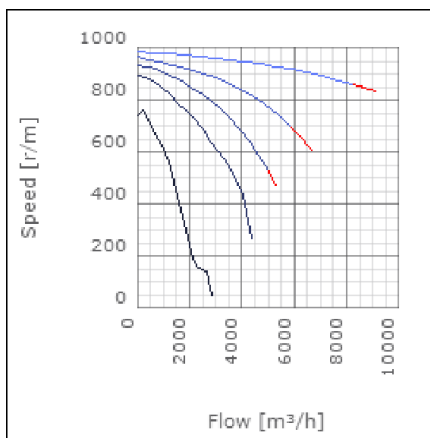
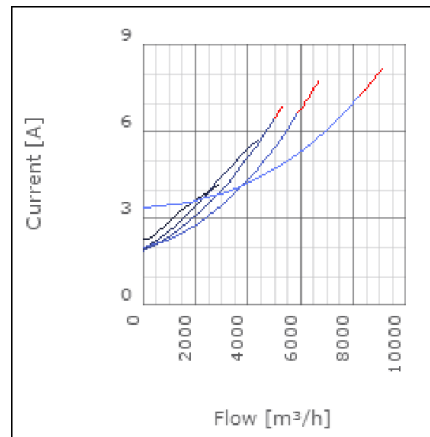
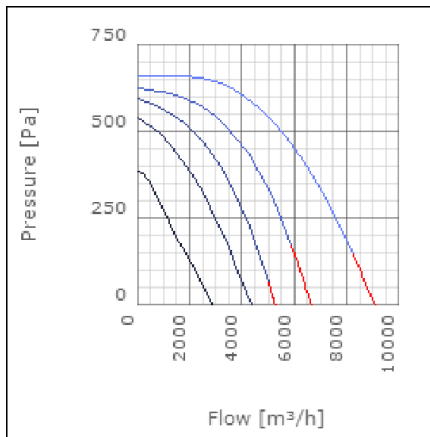

Sound

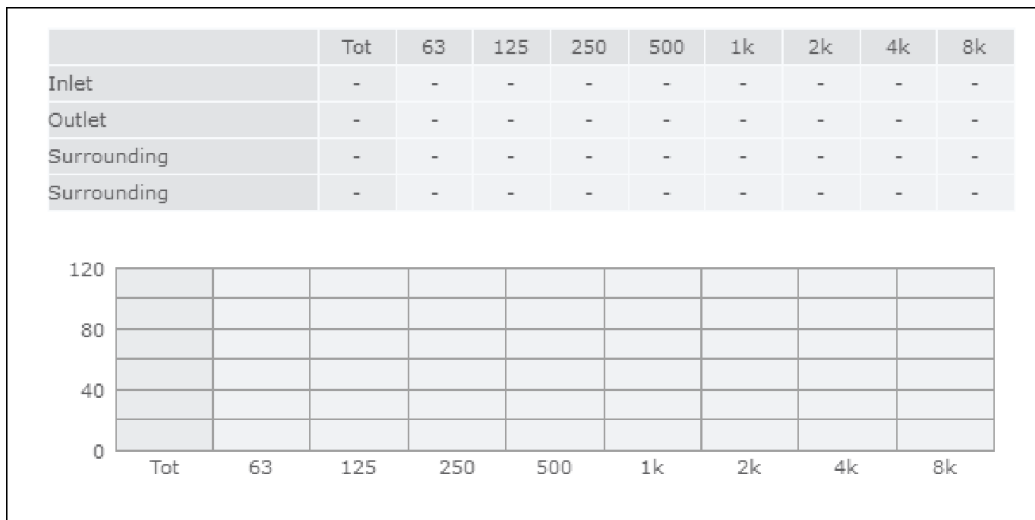
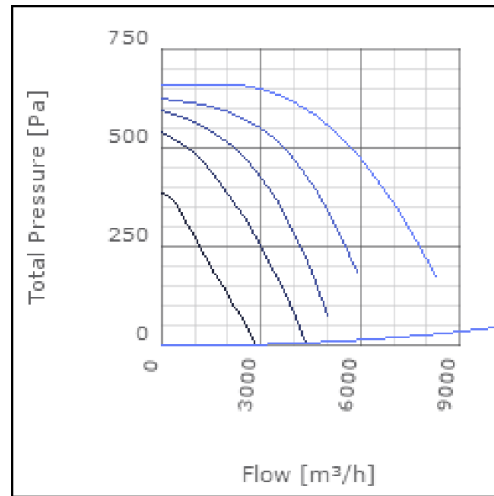
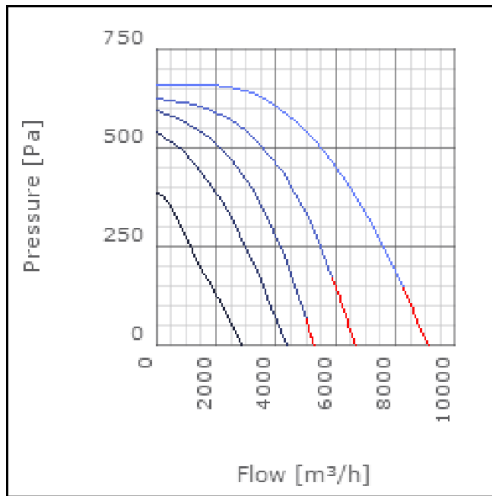

**Parameter**

Distance: 3.000  
 Propagation type: Hemi-spherical  
 Equivalent absorption area: 20.00

## Dimensions

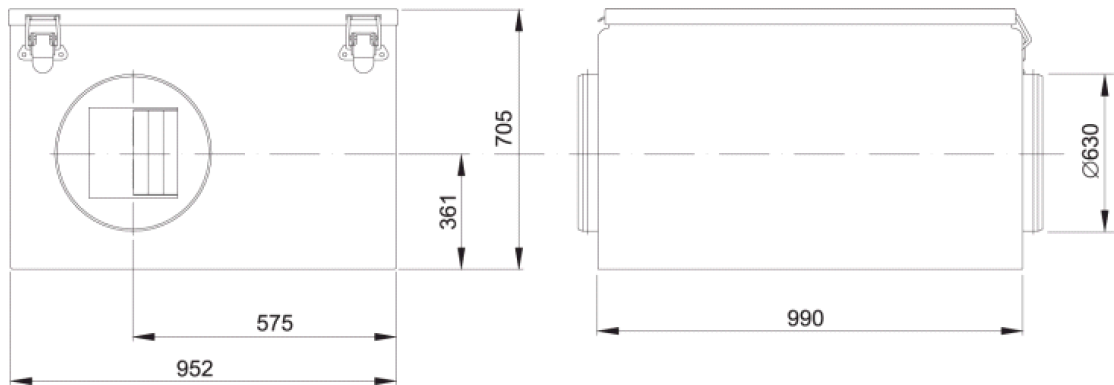

## Wiring diagram

4040004

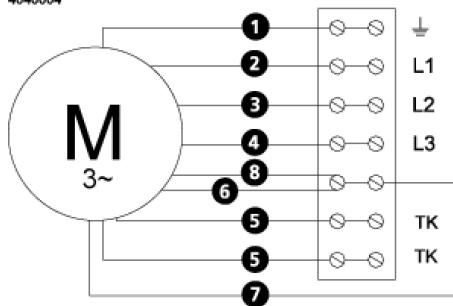

- (M) = Fan Motor
- (M1) = Fan Motor
- (M2) = Fan Motor
- (M3) = Rotor Motor
- 1 = Yellow/Green
- 2 = Black
- 3 = Blue
- 4 = Brown
- 5 = White (TW)
- 6 = Orange
- 7 = Grey
- 8 = Red
- 9 = Green
- 10 = Violet

## Accessories

VRDT 11

VRTT 11

## Electrical accessories

BSV 630